

# Bob's Card Models

[www.bobscardmodels.com](http://www.bobscardmodels.com)



**Fairchild C-119G 'Flying Boxcar' (1:72)**  
Livery: Film "Flight of the Phoenix"

The Fairchild C-119 Flying Boxcar (Navy designation R4Q) was an American military transport aircraft developed from the World War II Fairchild C-82 Packet, designed to carry cargo, personnel, litter patients, and mechanized equipment, and to drop cargo and troops by parachute. The first C-119 made its initial flight in November 1947, and by the time production ceased in 1955, more than 1,100 C-119s had been built. Its cargo hauling ability earned it the nickname "Flying Boxcar".

N15501 made its way to Namibia, Africa during December 2003, to participate in a movie (remake of "The Flight of the Phoenix") and this took place in Namibia.

### **General characteristics**

Crew: 5

Capacity:

62 troops or 35 stretchers

Payload: 10,000 lb (4,500 kg) of cargo

Length: 86 ft 6 in (26.37 m)

Wingspan: 109 ft 3 in (33.30 m)

Height: 26 ft 6 in (8.08 m)

Wing area: 1,447 ft<sup>2</sup> (134.4 m<sup>2</sup>)

Empty weight: 40,000 lb (18,000 kg)

Loaded weight: 64,000 lb (29,000 kg)

Max takeoff weight: 74,000 lb (34,000 kg)

Powerplant: 2× Pratt & Whitney R-4360-20 radial engines, 3,500 hp (2,611 kW each) each

\*\* Alternate powerplant: 2× Wright R-3350-85 "Cyclone" radials, 2,500 hp (1,900 kW) each

### **Performance**

Maximum speed: 296 mph (257 knots, 450 km/h)

Range: 2,280 mi (1,980 nm, 3,670 km)

Service ceiling 23,900 ft (7,290 m)

Rate of climb: 1,010 ft/min (5.1 m/s)

Wing loading: 44 lb/ft<sup>2</sup> (216 kg/m<sup>2</sup>)

Power/mass: 0.11 hp/lb (180 W/kg)

### **Building Instructions**

Print all sheets on 160g card, except Sheets 5 & 11 (Paper).

When gluing card parts at right-angles to another piece (eg bulkheads to the outer skin), holding together with fingers until dry usually results in the 'skeleton' image of the bulkheads - not nice! Hold together with 2 flat pieces of wood or plastic.

NOTE: Insert the bulkheads using a cocktail stick (or even better, I use a long screw) pushed into a tight hole in the centre of each bulkhead. The fit of the bulkhead must be flush, not tight, otherwise ugly "ribbing" will be visible on the fuselage.

Green areas must be cut out, BUT usually after gluing any folds.

TIP: Where applicable, using a pencil write the part numbers on the back of each part before cutting out, as well as the direction REAR and FRONT.

### **Fuselage**

1. Cut out bulkheads **A - G**, reinforce by gluing on card to give 3x thickness.
2. Cut out parts [2] to [5], preferably larger than shown to include the green markers for folding. Fold all green line pairs 90° with a 5-10mm diameter rod, cut exact shape, glue on all tabs and close form by gluing.
3. Nose cone [1] : cut out, glue tab, cut out the tiny strips, carefully form, glue. Glue in position on [2].
4. In unit [1/2], push in and glue b'hd **A**, followed by **B**.
5. Add and glue in place, the Front Wheel Compartment [2A] in such a way, that the 2 side flaps protrude from the fuselage.
6. Add (inside the fuselage) 2 ca 5gm weights left and right of the wheel compartment, liberally glue.

7. Glue [3] onto part [2]. Push in b'hd C (on a cocktail stick) as far as it goes, glue in place, followed likewise by b'hd D.
8. Glue [4] onto part [3]. Glue b'hds E and F in place (position as shown in diagram).
9. Glue [5] onto part [4]. Push in b'hd G as far as it goes, glue in place.
10. Cut out Tail [6], glue tabs, glue and fit on [5] .

#### **Main Wings** (Use Diagram 1 to form the correct angling)

11. Cut out the 2 strengthened Wing Stabilisers [7] and the 3x strengthened struts -- glue the 6 strut parts together according to the instructions, glue on the struts in the positions marked.
12. Cut out the wing parts [8aL], [8bL], fold wing and glue long tab as well as the wing tip. Push [8aL] through [8bL] and glue in position at an angle of 15° from the horizontal. Push in the left-hand Wing Stabiliser with glued struts a to e into position as far as it will go.
13. Join the left and right wings with the 2 strips [9], which are glued **inside** the wings, up to the dotted lines **inside** the wing. These strips must be glued on as upside-down V's. One of the strips is glued onto the spars inside each wing.
14. Repeat for the Right-Hand.
15. Cut out the area marked green on the fuselage. Carefully insert the wing unit - carefully increasing the size of the cut area to give a flush fit. Glue well in place.
16. Any irregularities in the join fuselage-wing can be corrected using the 'reserve fuselage' printed on the paper sheet.

#### **Booms (2), Rear Fin and Wing**

17. Cut out all parts [10] to [14]. Parts [13] and [14] should be made 3x thick by gluing twice on card, and their centres pierced with a pin to about 1mm diameter..
18. Glue all tabs, and close the 3 cylindrical forms.
19. Glue in b'hd [13], by pushing it from the rear end in place to the front, countersunk by about 1-2mm.
20. Likewise b'hd [14] as far as it goes.
21. Join the 3 main parts together. When dry, cut out the green areas on [11]; these are for inserting the main wings.
22. Cut out and glue [10A] onto [10].
23. Undercarriage door flaps: cut along the red lines, and bend back flap.
24. Insert the wing through the parts, so that they lie centrally over the bend in the wings. Do not glue yet.
25. On the rear of parts [12], cut the slits which will receive the rear wing and fins.
26. Cut out parts [15] to [17], fold, glue tabs, glue in place on the beams.
27. When dry, glue the units with a bead of glue, to the main wings.

#### **Wheels, Undercarriage**

28. Cut out all wheel strips, roll and glue the 5 wheels.

#### **Landing Gear**

29. Assemble according to the instructions on the Sheet, and glue in place in the positions marked in the undercarriage compartment on the wings (main landing gear); and under the fuselage nose (front wheel).

#### **Propellers (4-bladed)**

30. Cut out the 2 propellers, fold according to the instructions and glue.
31. Glue each on a cocktail stick, cut out the cones, glue tab and cut slits for the propeller. Glue in place.
32. Insert in the positions provided, without glue.
33. Bend the blades to the correct form.
- 34.** Cut out the 2 exhaust [19], roll and glue. Cut out the 2 green dots on the engines, insert the exhausts and glue in place.

#### **Accessories**

35. Roll/glue the 5 parts [18] on a pin. When dry glue in position -- 2 on nose cone, 2 in the positions marked (white dots) on top of fuselage just behind the cockpit, and the 5<sup>th</sup> on top of fuselage near rear (also white dot).

---oooOooo---

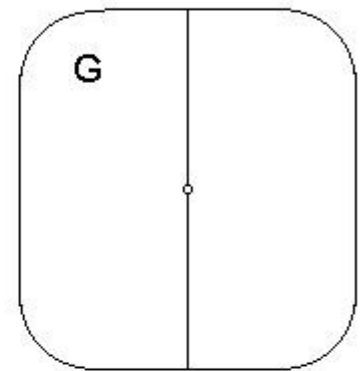
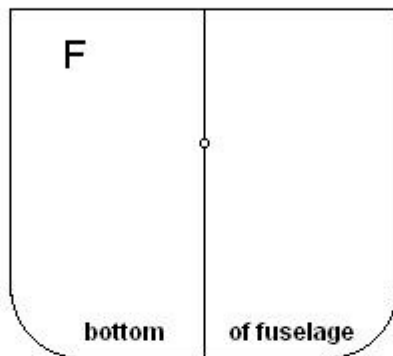
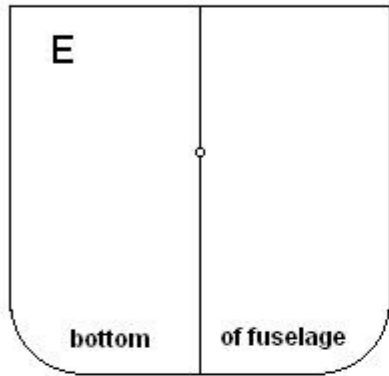
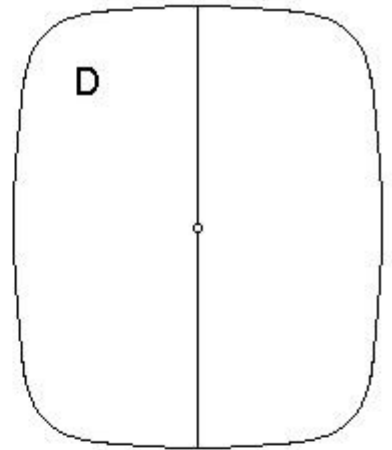
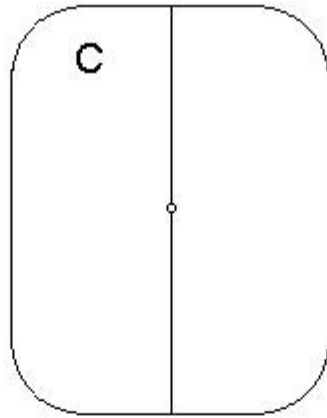
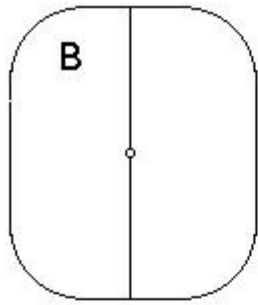
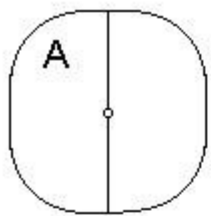

**Bulkheads** Make 3x thick

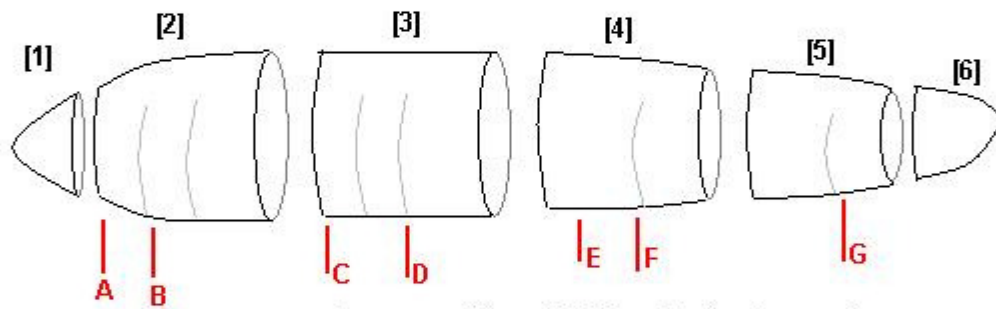

**Approx. position of bulkheads in fuselage parts**

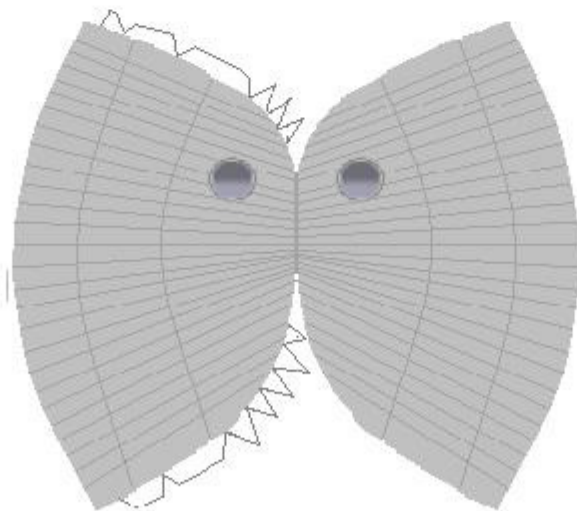

**[6] Tail** Fold and glue tabs

**Sheet 1**

Flying Boxcar

**Version 2**  
(Flight of the Phoenix)

www.bobscardmodels

© Bob Schedler 2007

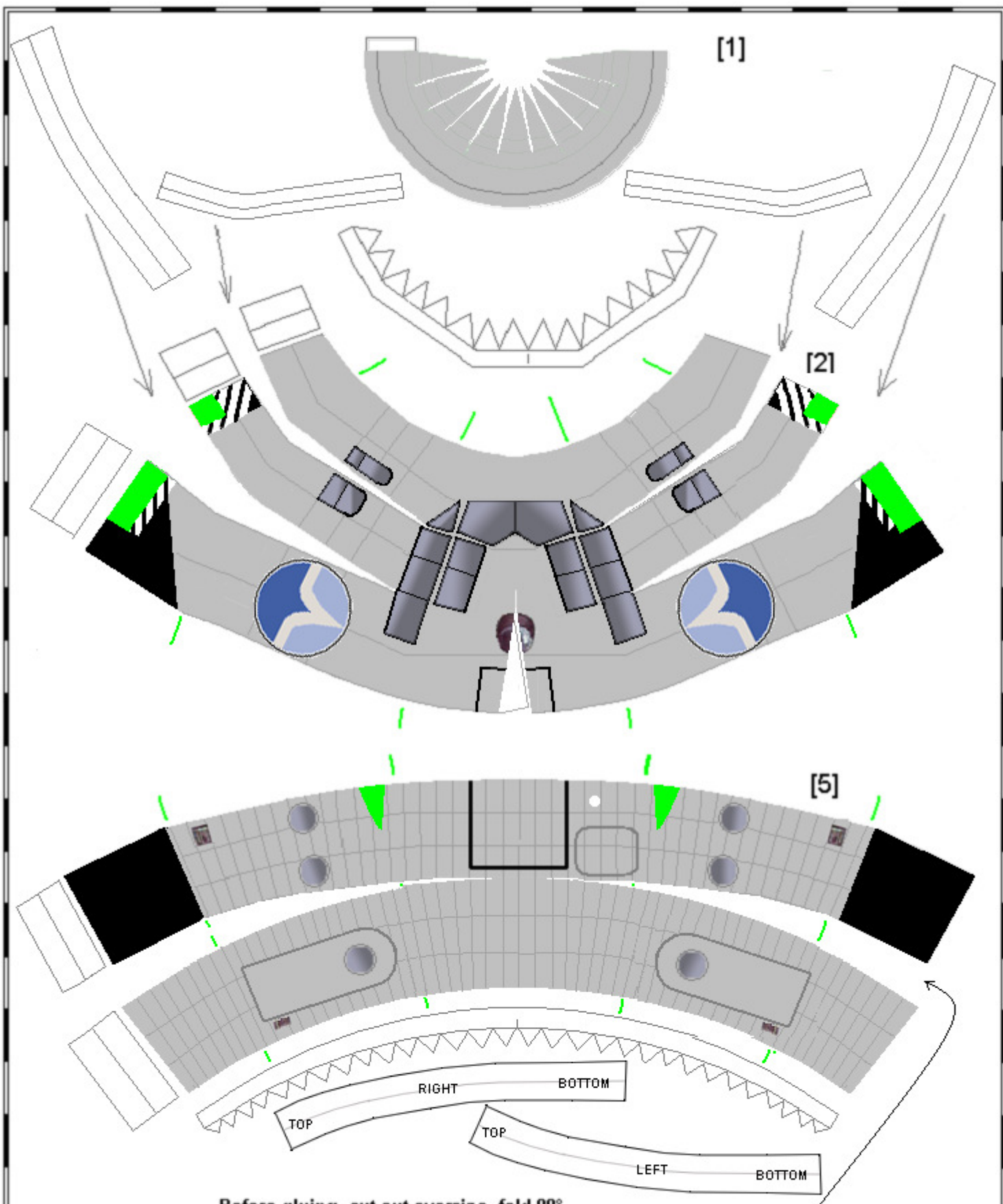

Before gluing, cut out oversize, fold 90° along each green pair of lines, and then cut to final shape. Fold using a ca 5.8mm diameter rod.

## Sheet 2

Flying Boxcar

Version 2  
(Flight of the Phoenix)

[www.bobscardmodels](http://www.bobscardmodels)

© Bob Schedler 2007

[3]

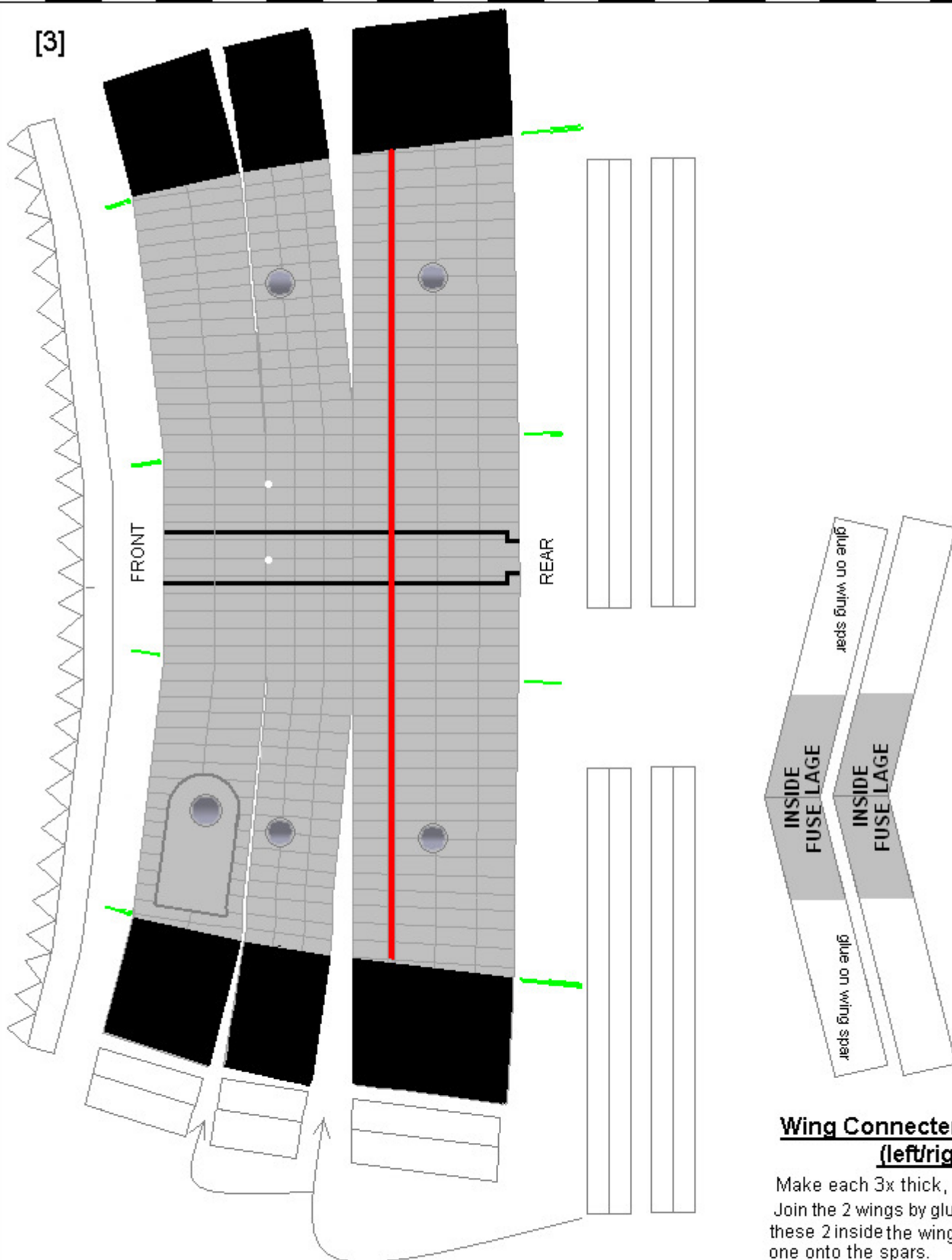

**Wing Connectors [9]**  
**(left/right)**

Make each 3x thick,  
Join the 2 wings by gluing  
these 2 inside the wings ,  
one onto the spars.

**Sheet 3**

Flying Boxcar

Version 2

(Flight of the Phoenix)

Before gluing, cut out oversize, fold 90° along each green pair of lines, and then cut to final shape. Fold using a ca 5-8mm diameter rod.

www.bobscardmodels

© Bob Schedler 2007

[4]

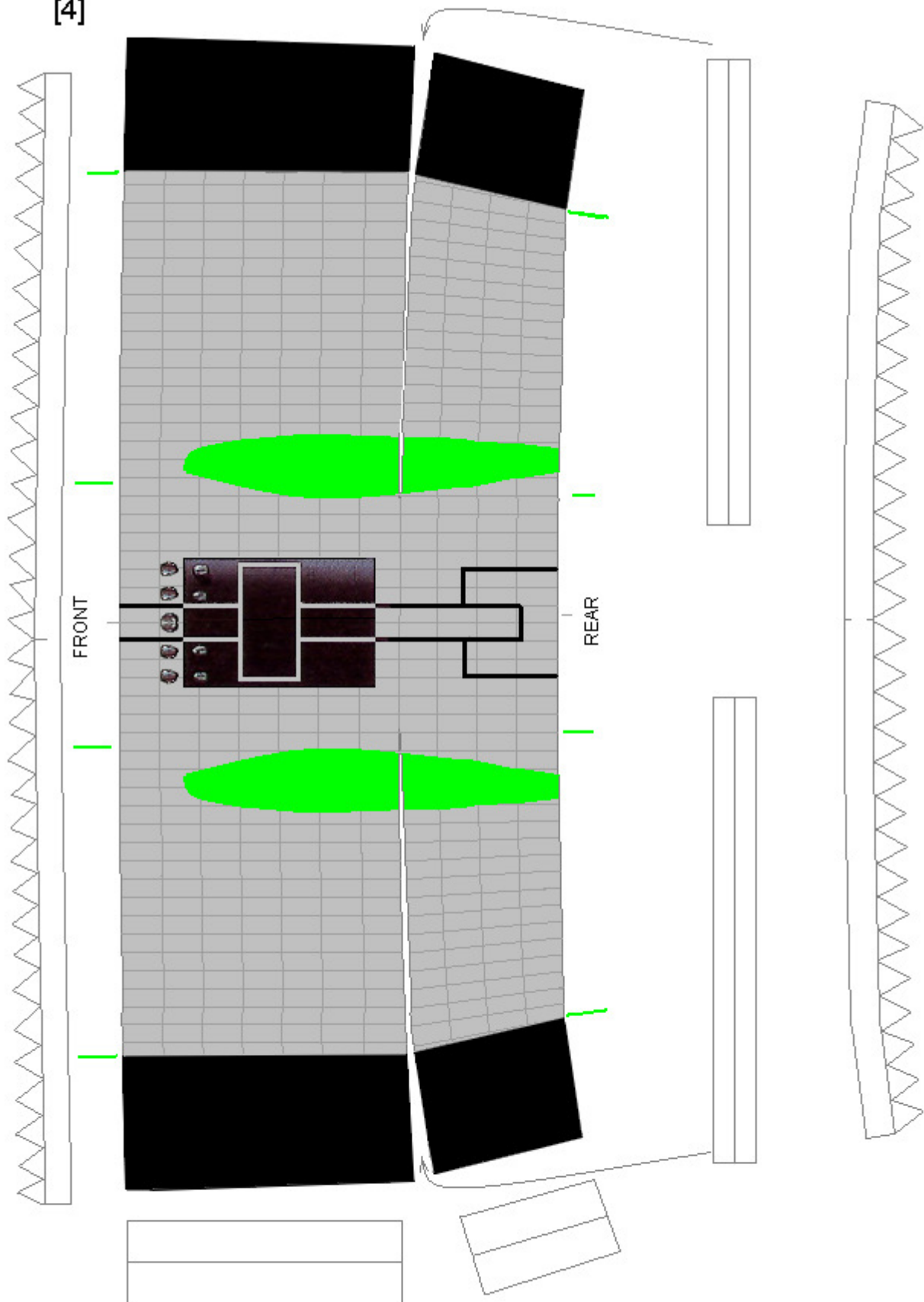

## Sheet 4

Flying Boxcar

Version 2  
(Flight of the Phoenix)

Before gluing, cut out oversize, fold 90° along each green pair of lines, and then cut to final shape. Fold using a ca 5-8mm diameter rod.

[www.bobscardmodels](http://www.bobscardmodels)

© Bob Schedler 2007

**Aerial, sensing equipment [18]**



**Exhausts [19]**

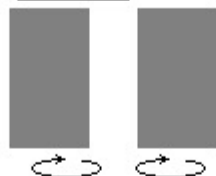

**'Reserve fuselage'**

For correcting blemishes etc.

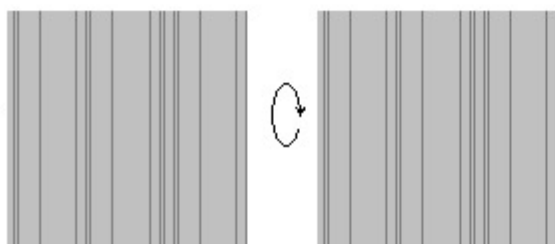
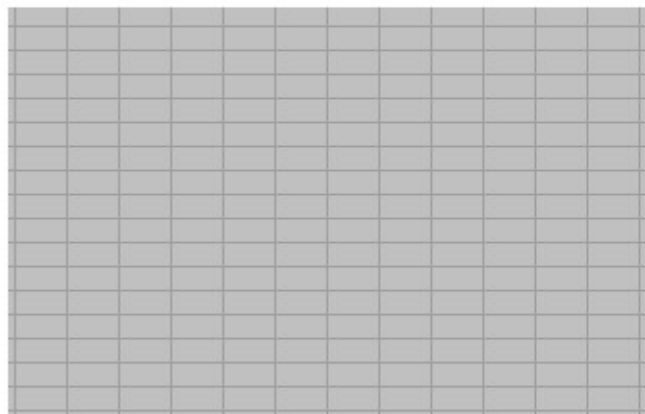

**Wheel strut sleeves for the thicker central Oleo struts.**

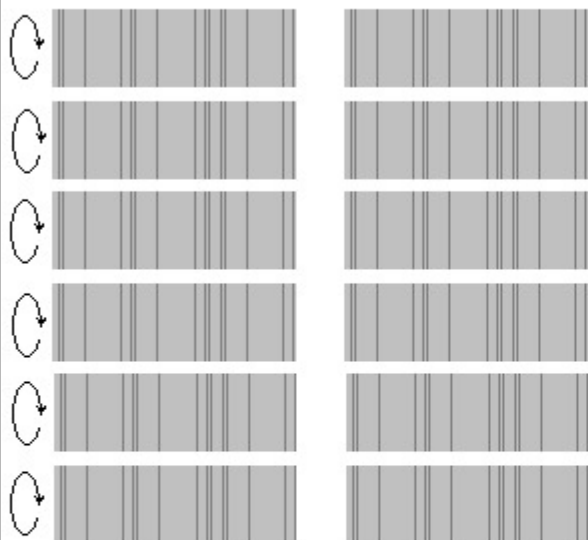

**Wheel axle sleeves**

Roll and glue, slip on wheel axles (cocktail sticks)

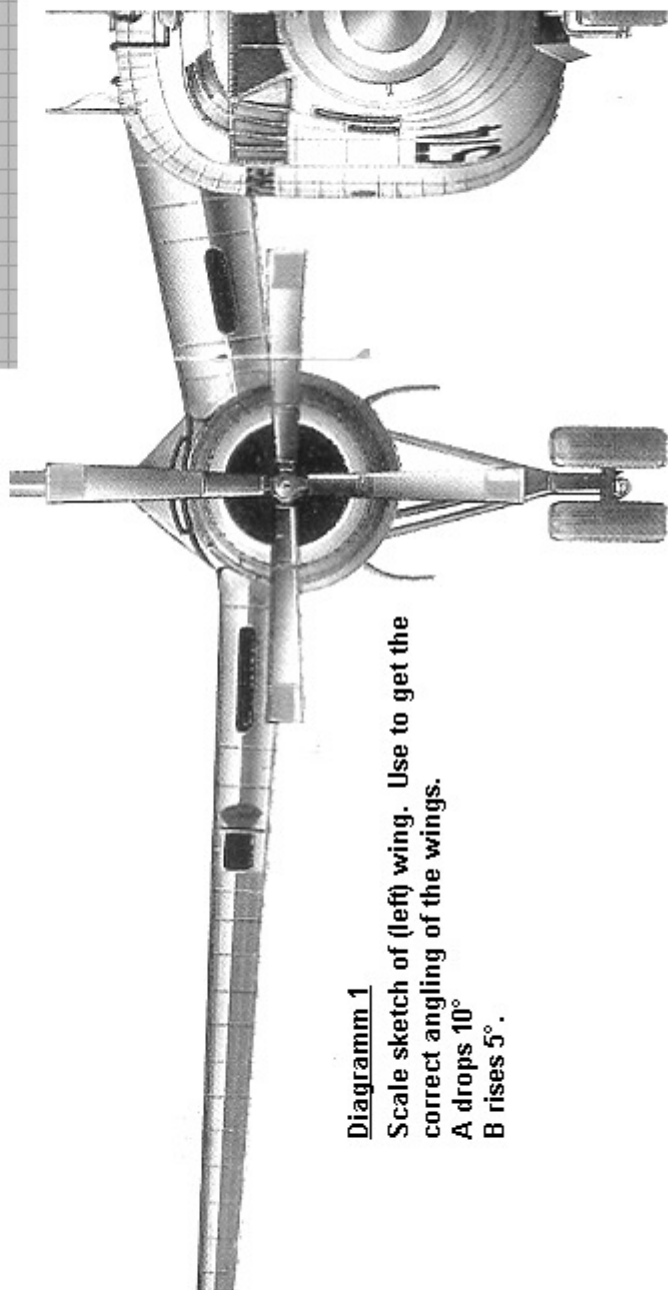

**Diagram 1**

Scale sketch of (left) wing. Use to get the correct angling of the wings.

A drops 10°

B rises 5°.

**PRINT ON 90g PAPER**

**Sheet 5**

Flying Boxcar

Version 2

(Flight of the Phoenix)

**Left Wing**

[9]



**Bottom**



**Top**

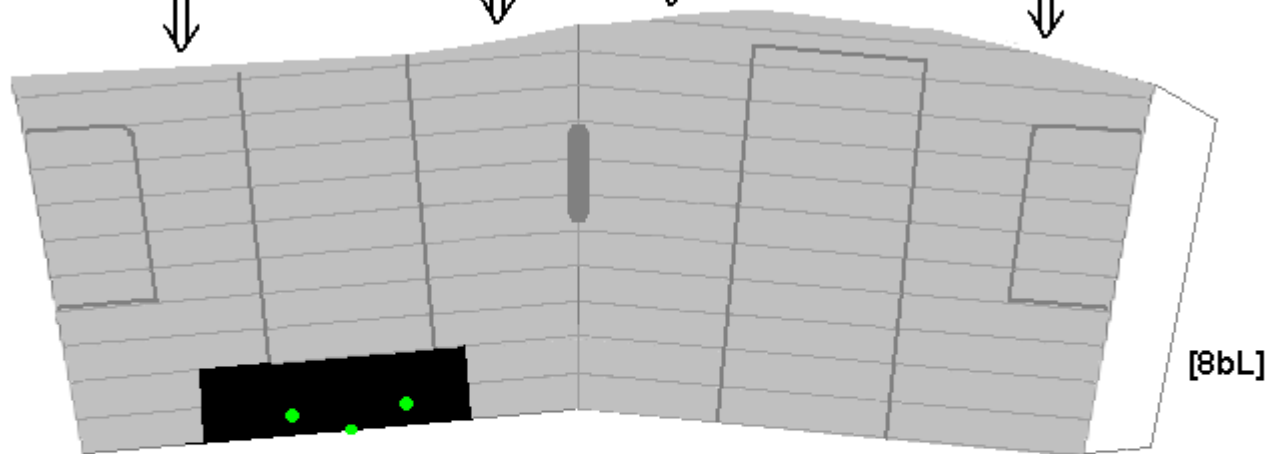

[8bL]

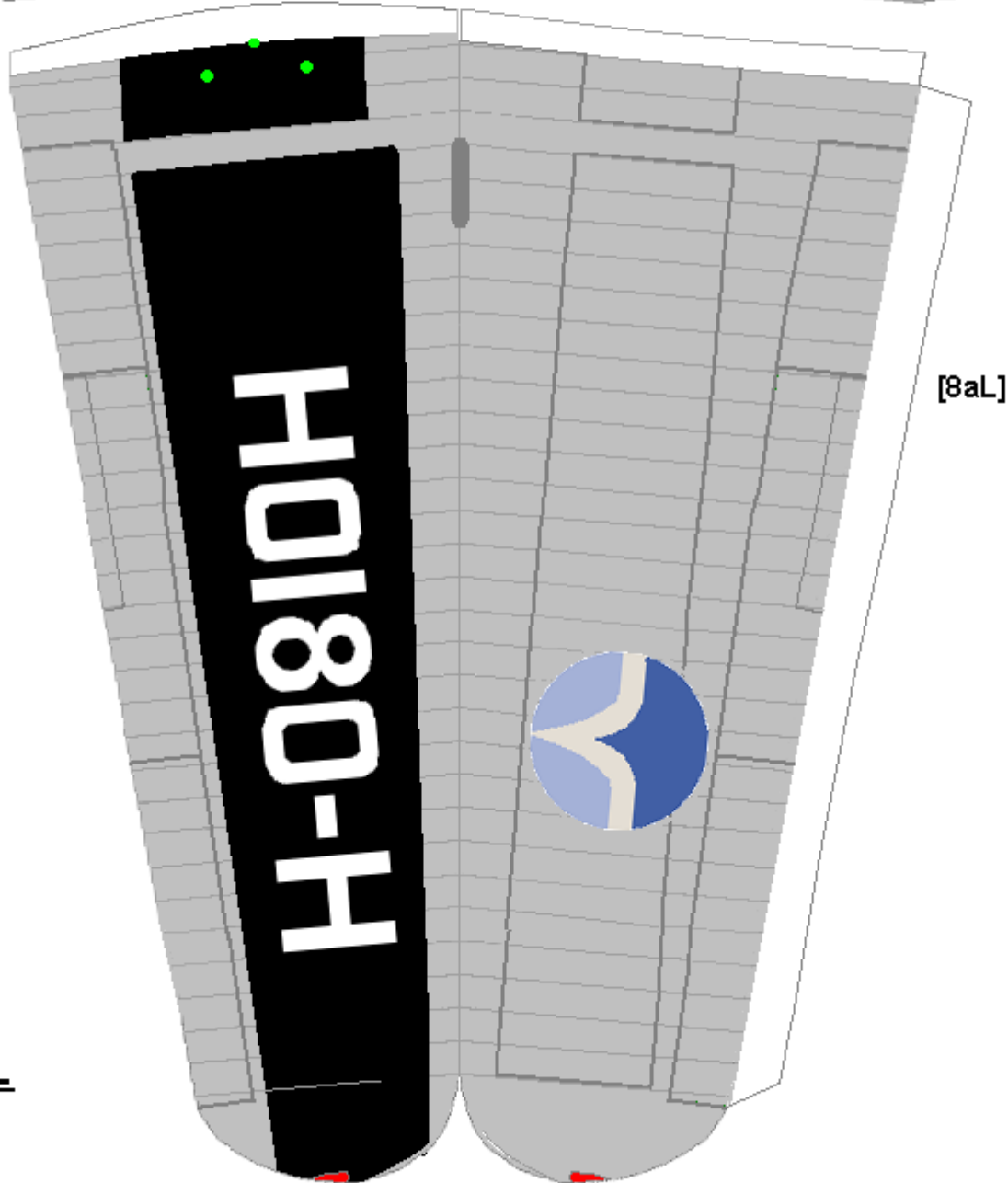

[8aL]

**Sheet 6L**

Flying Boxcar

**Version 2**  
(Flight of the Phoenix)

[www.bobscardmodels](http://www.bobscardmodels)

Right Wing

[8aR]

H-0810H

[8bR]

**Sheet 6R**

Flying Boxcar



**Version 2**  
(Flight of the Phoenix)

[www.bobscardmodels](http://www.bobscardmodels)

© Bob Schedler 2007

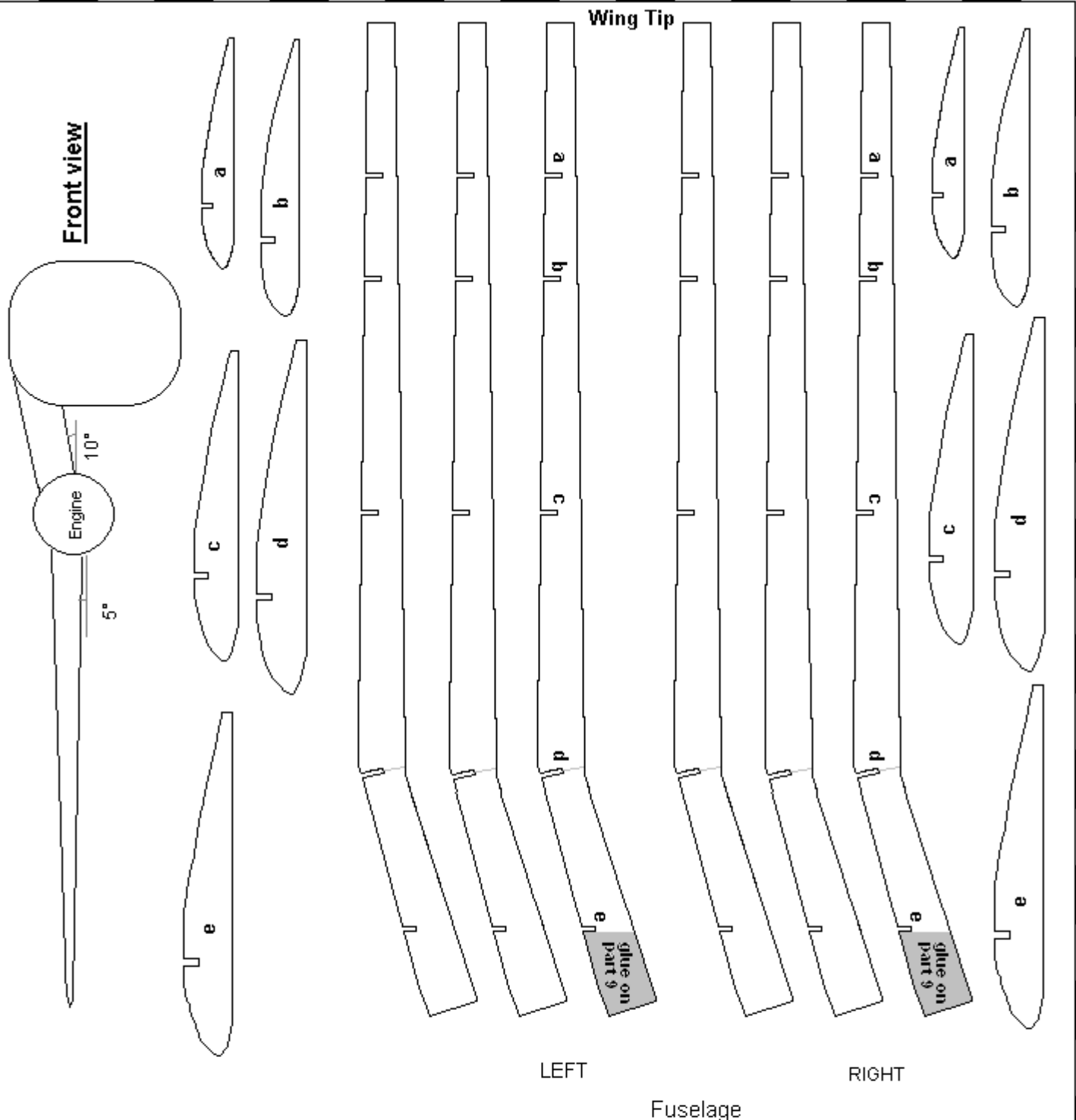

## Sheet 7

Flying Boxcar

## Front Wing Stabiliser [7]

To increase strength, the stabiliser is 3x thickness - glue the 3 component parts together

NOTE: cut out slots only AFTER gluing the six components together.

Version 2  
(Flight of the Phoenix)

www.bobscardmodels

© Bob Schedler 2007

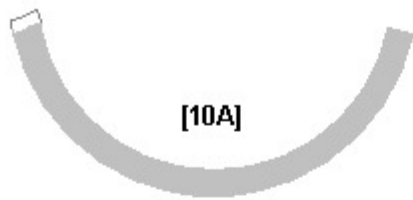

[10A]

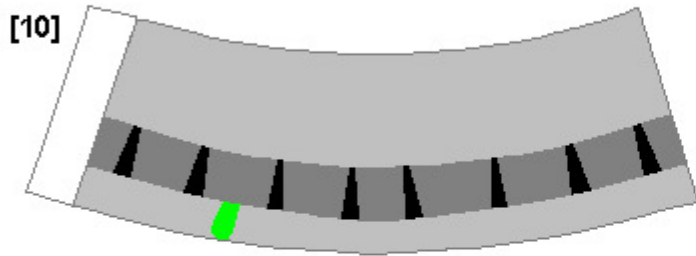

[10]

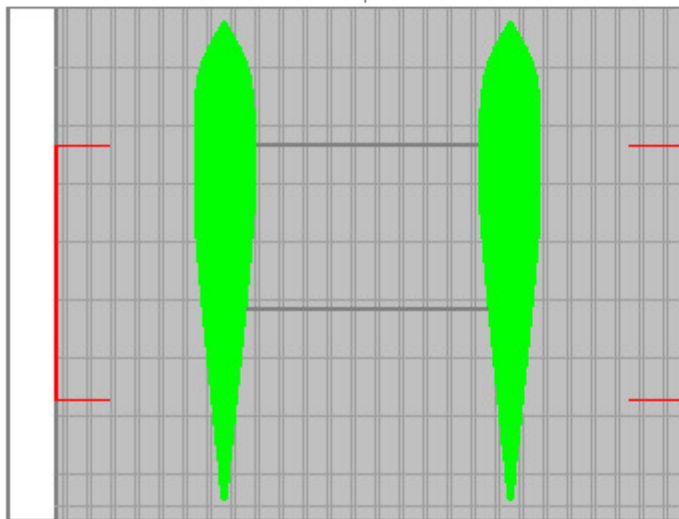
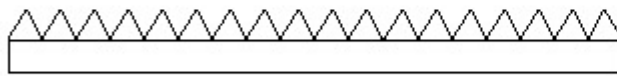

[11]

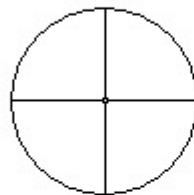

[14]

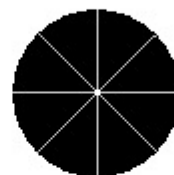

[13]

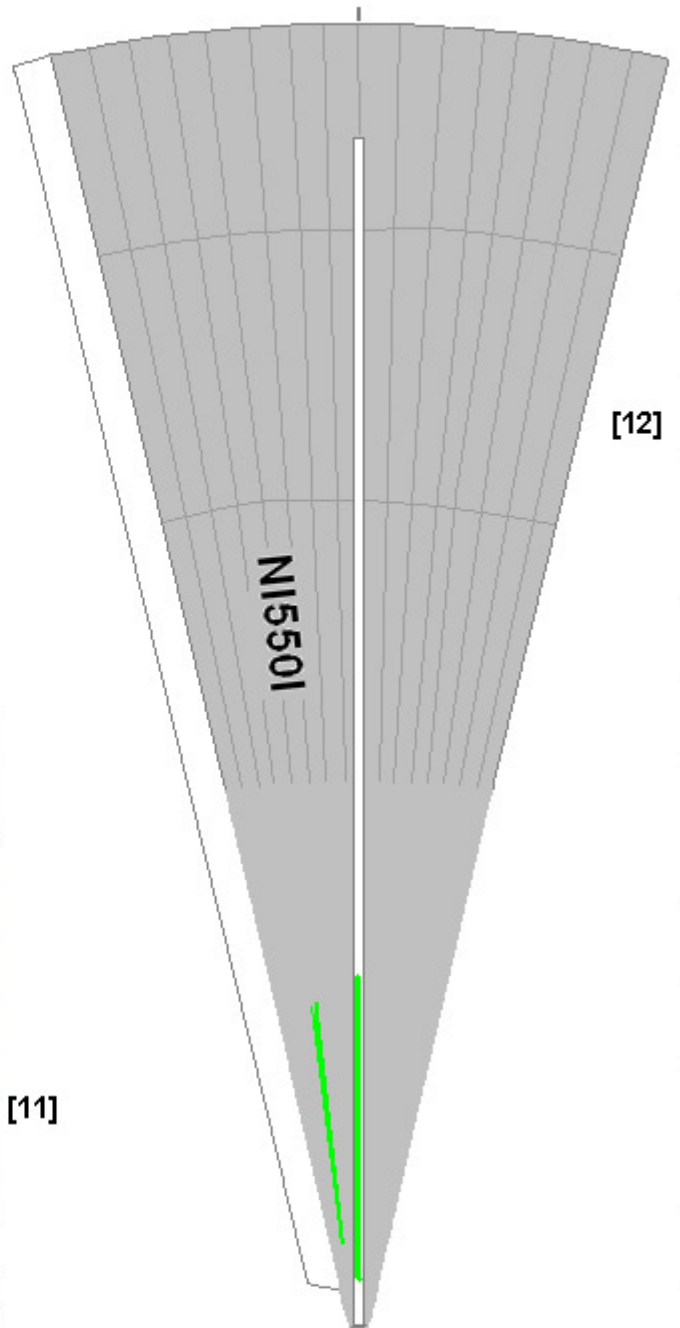

[12]

## Sheet 8L

Flying Boxcar

Version 2  
(Flight of the Phoenix)

[www.bobscardmodels.com](http://www.bobscardmodels.com)

© Bob Schedler 2007

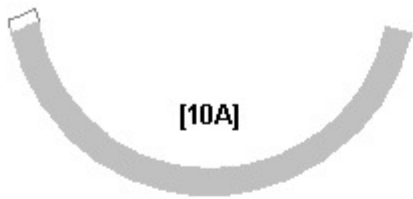

[10A]

[10]

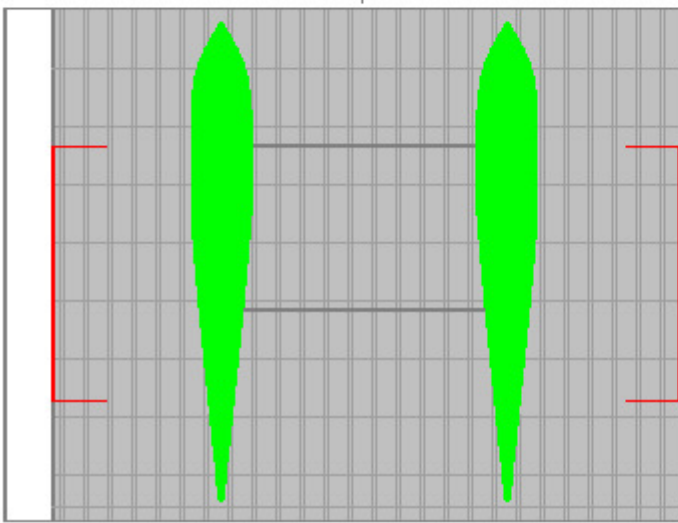
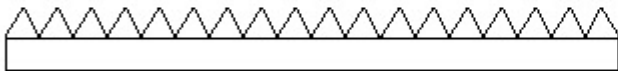
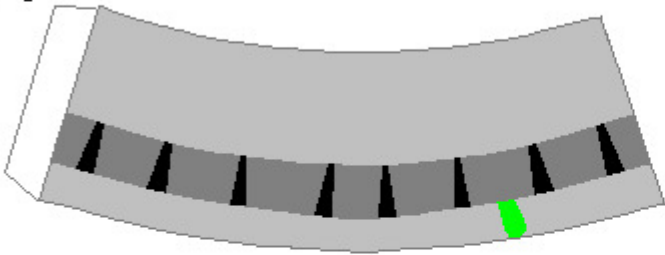

[11]

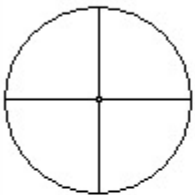
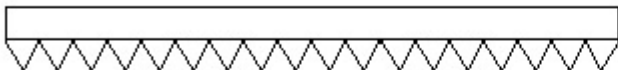

[14]

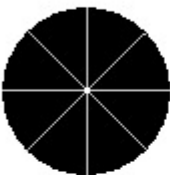

[13]

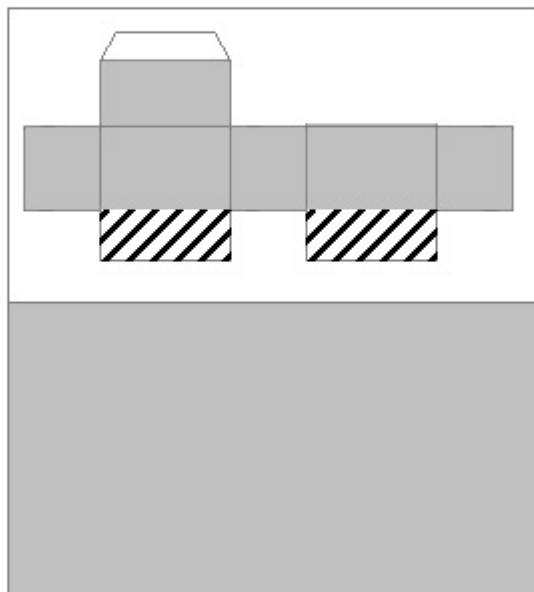

[2A]

**Front Wheel Compartment**

Fold the 2 halves, cut out and fold and glue

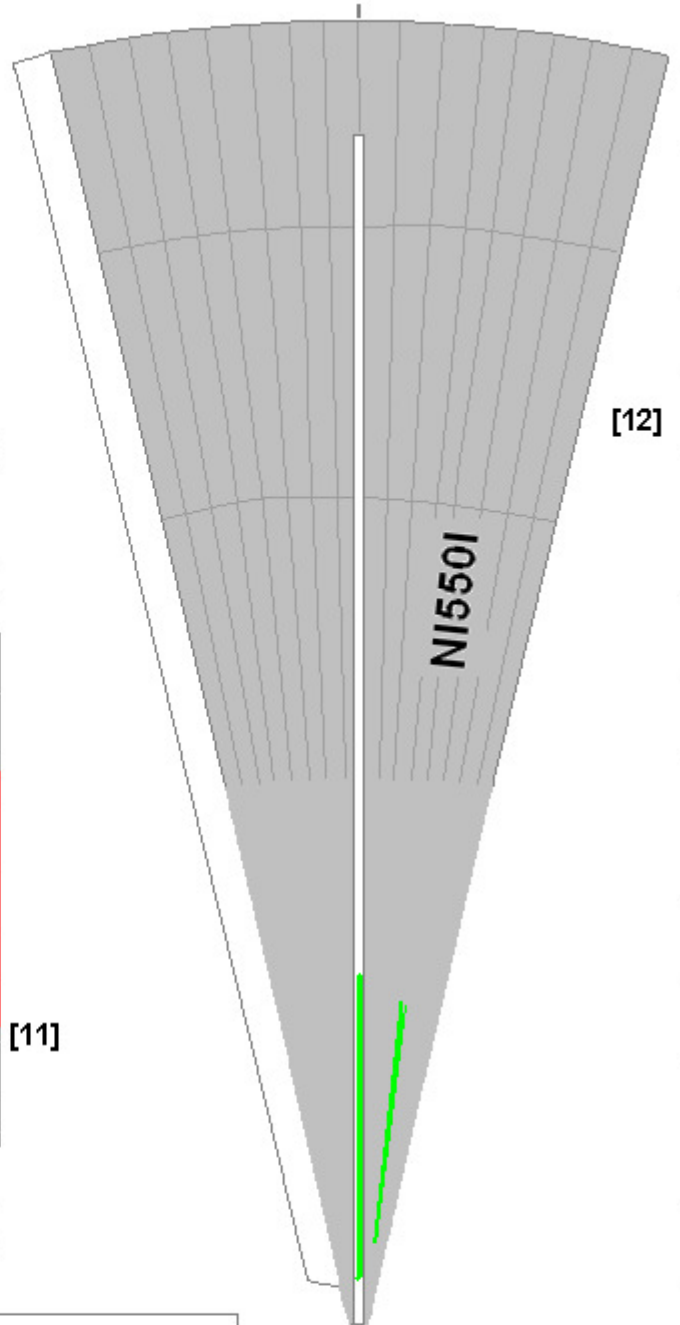

[12]

**Sheet 8R**

Flying Boxcar

Version 2  
(Flight of the Phoenix)

[15]

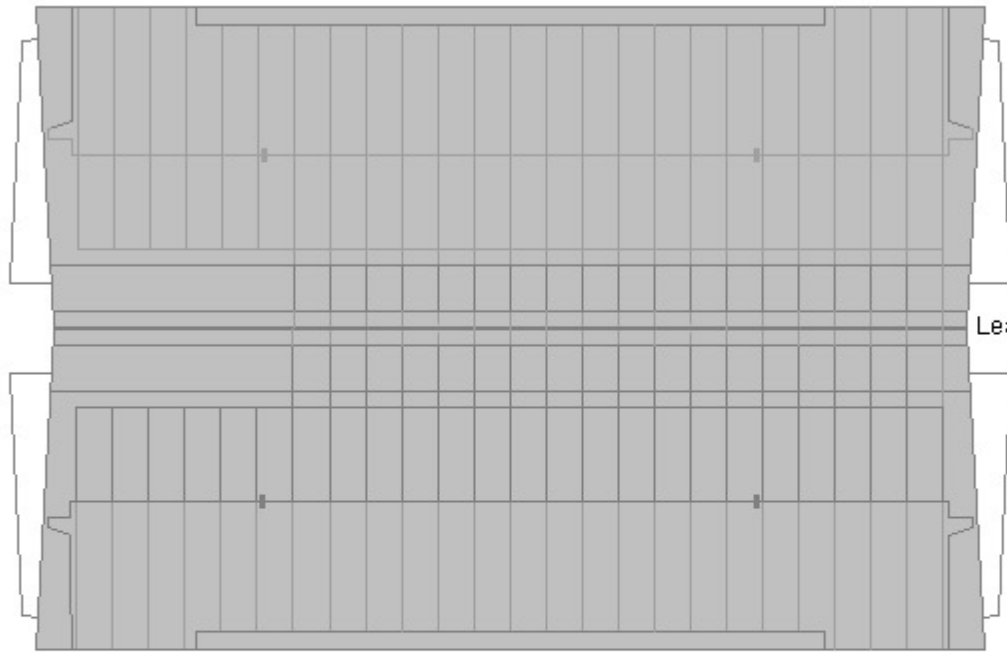

Top

Leading edge

Bottom

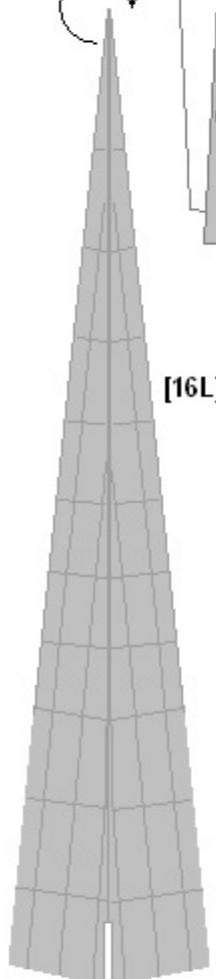

[16L]

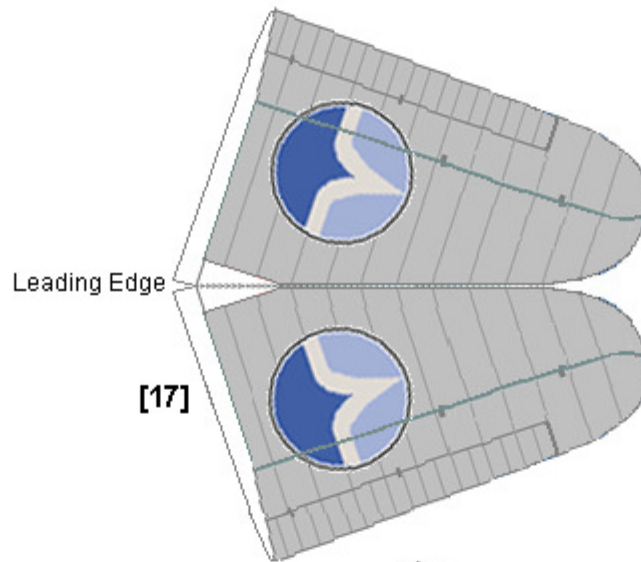
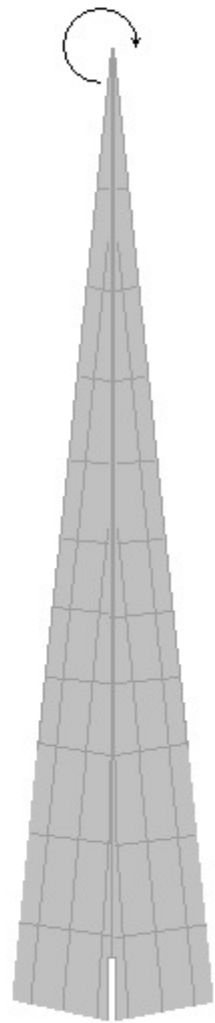

[17]

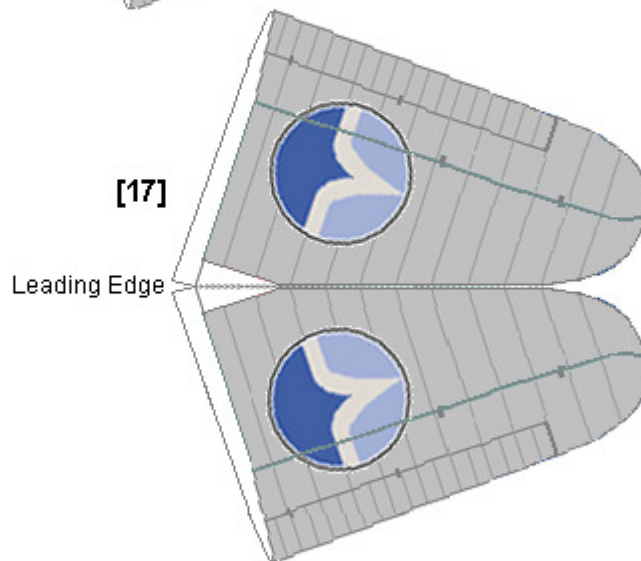

[17]

### Sheet 9

Flying Boxcar

Version 2  
(Flight of the Phoenix)

[www.bobscardmodels.com](http://www.bobscardmodels.com)

© Bob Schedler 2007

end

end

end

end

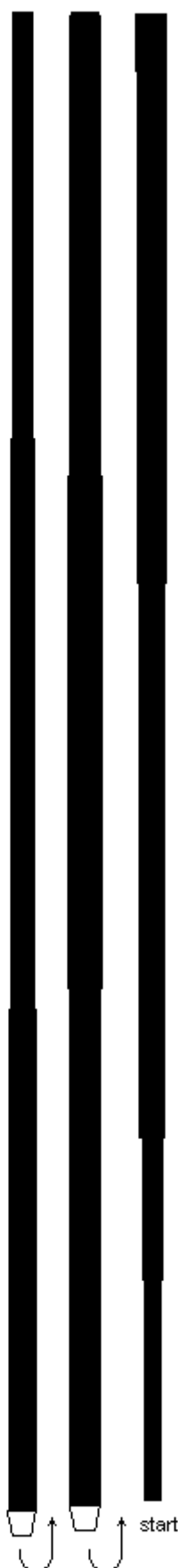
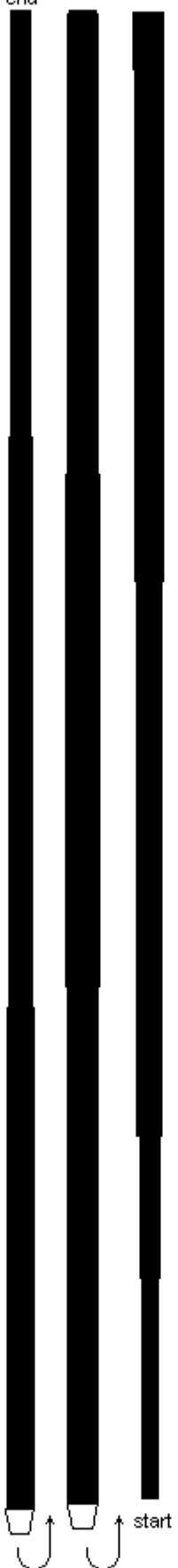
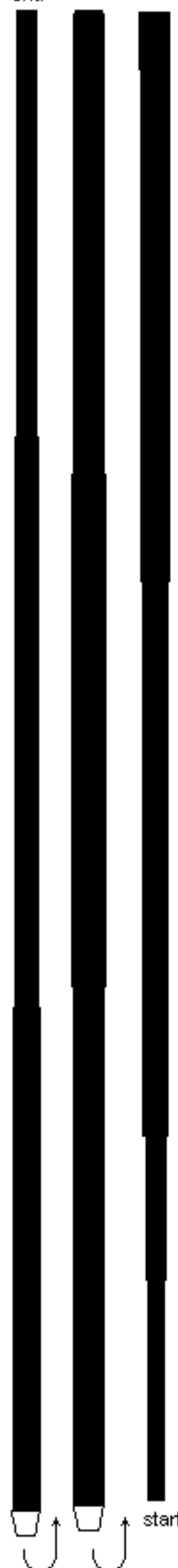
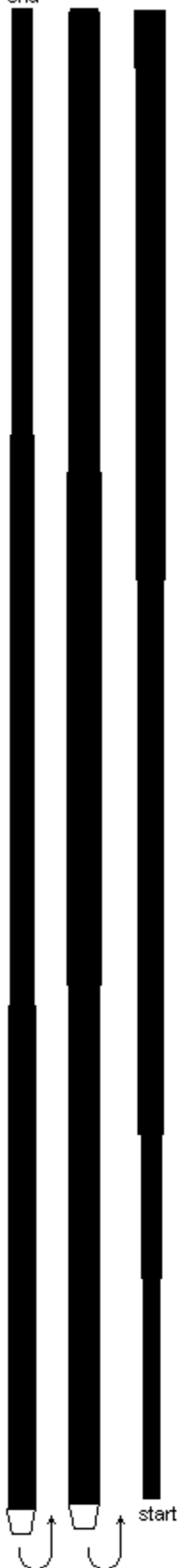

### Sheet 10

Flying Boxcar

Version 2  
(Flight of the Phoenix)

### Main Wheels (4)



### Nose Cones

### Props (2)

### Front Wheel (1)

## Main Wheels

All parts shown to scale

1. Cut 2 cocktail sticks to give A and B. It will be necessary to sharpen one end of the stick B.
2. Drill a tiny hole in the middle of B.
3. Insert A into B and glue liberally.
4. On each end of B, push on wheel and glue well.

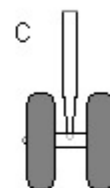
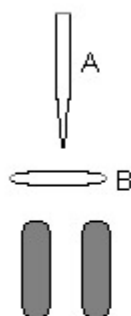

5. Join 2 cocktail sticks as shown in a V-\*form (angle of about 30°). Glue join.
6. Make 3 more of these then cut off at the position marked,
7. Glue 2 of these (D) on either side of C, not parallel to each other, but about 10-15° off parallel (see Front view below).
8. When glue is dry, add more glue to give firm joins.

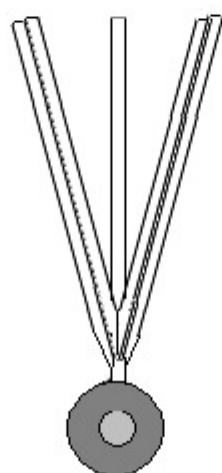
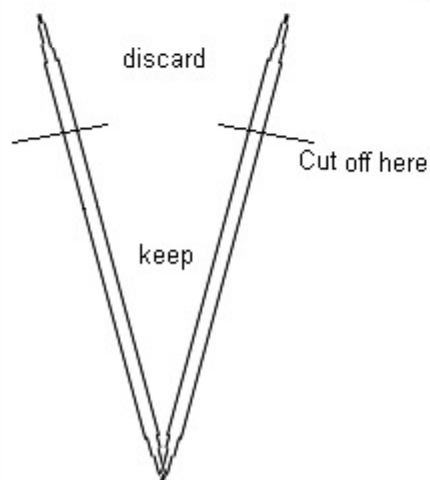

Side view

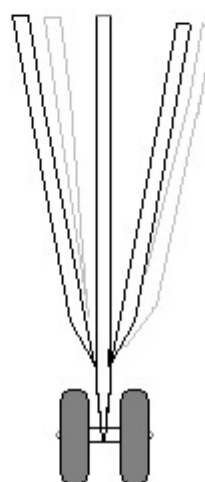

Front view

**NB: For authenticity, use the Wheel axle sleeves on the relevant Sheet. To give extre thickness to the central Oleo strut, use the long Wheel axle sleeve.**

## Front Wheel

1. Bend the tips (2-3mm) of one end of 2 cocktail sticks to 90°. Should they break off, try moistening them first with water.
2. Insert each tip in either side of the wheel, glue liberally.
3. Cut off to give a total height of 37mm.

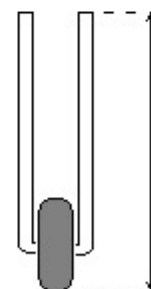
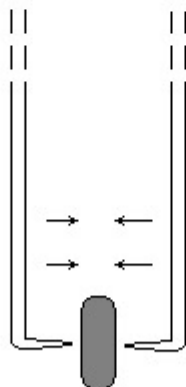

**PRINT ON 90g PAPER**

## Sheet 11

Flying Boxcar

Version 2  
(Flight of the Phoenix)

www.bobscardmodels

© Bob Schedler 2007